

NexusLED®
Simple is Better



DU Series
REPLACEABLE LED DOWNLIGHT
Simply turn and switch on



TWO-PIECE DESIGN

REPLACEABLE DOWNLIGHT

Easy install and replacement, no more breaking plaster ceiling problem

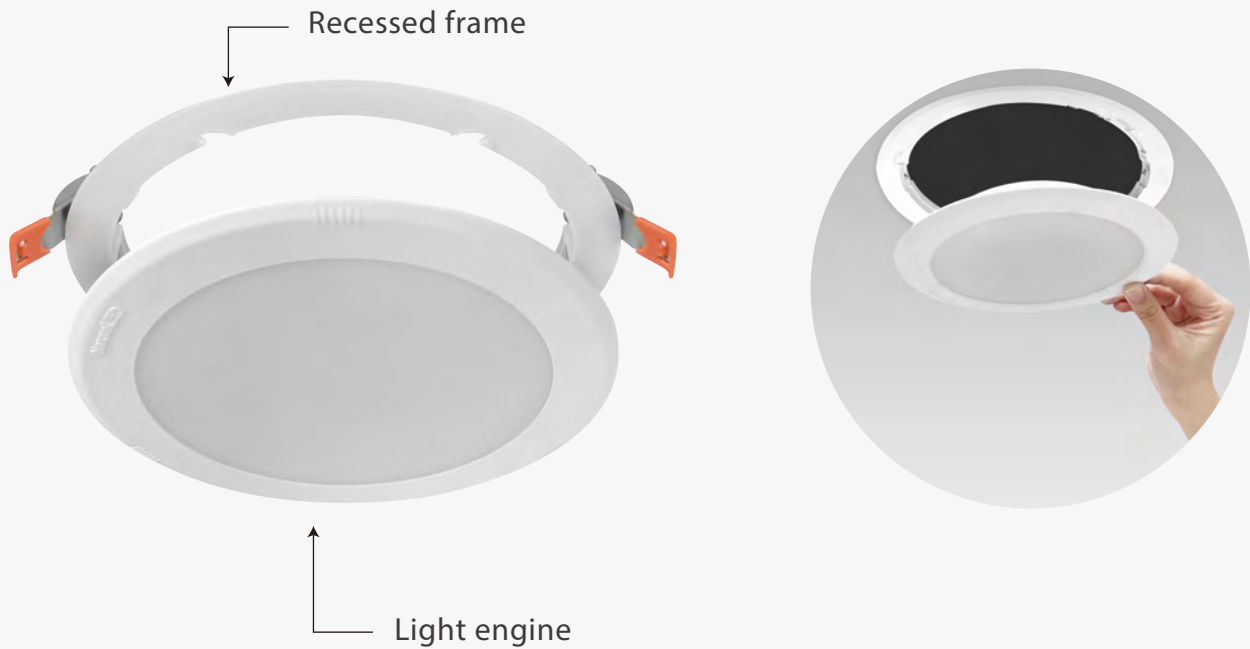

SIMPLY PLUG AND PLAY

One step turn and locked

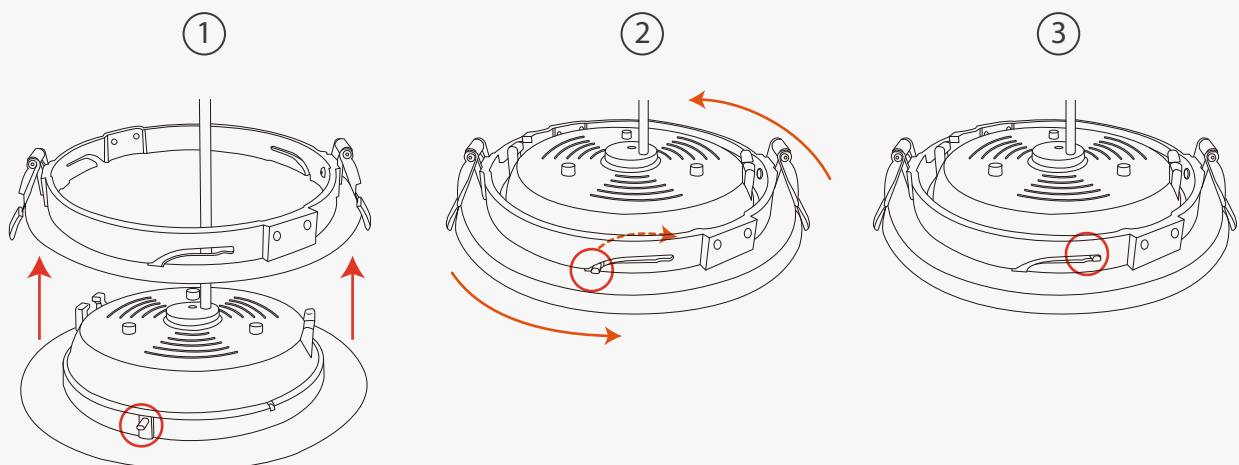

DU6RR-C15-DOB-RF

New downlight with recess frame provided for easy maintenance. No more breaking plaster ceiling feedback.

FEATURES

- Energy savings of up to 60%
- No mercury or toxic gases
- Driverless

BENEFITS

- Reduce energy costs
- Low maintenance costs
- Easy and quick installation
- Problem free on replacement



DIMENSIONS

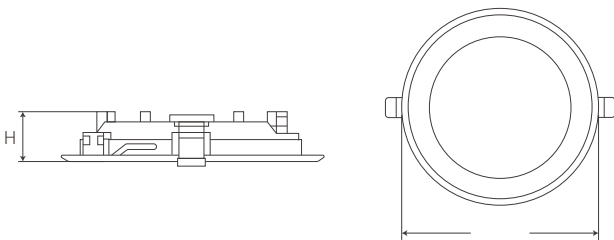

Detail	H	Ø
Size	32.5mm	171mm
Cut-Out	-	153mm

PHOTOMETRY

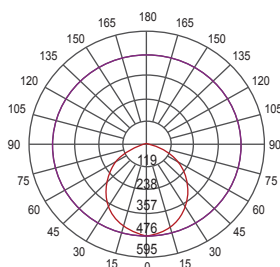

APPLICATIONS

Residential, Offices, Factories

PRODUCT SPECIFICATIONS

AC Input: 100~240Vac

System Power: 15W ± 1W

Luminaire Efficacy Rating (LER): >85 lm/W

Luminous Flux: 1,230 lm

Color Temperature: 6500K (available for 3000K, 4000K)

Color Rendering Index (CRI): >80

Beam Angle: 120°

Operating Temperature: -20°C ~ +45°C

Storage Temperature: -20°C ~ +80°C

Lifetime (typical): 30,000 hours at ta 25°C

LED Lumen Maintenance: LM80

Electrical Safety: Class I

Compliant: IEC, CE

Weight: 450g

Luminaire Housing Material: Polycarbonate

Luminaire Color: White

IP Rating: IP20

NexusLED®
Simpler is Better

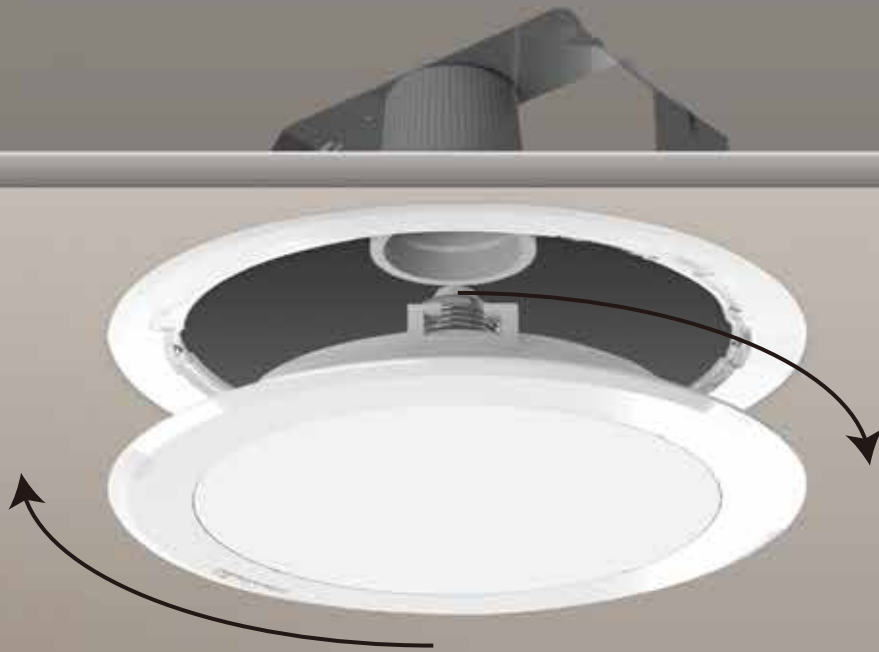

DU Series-E27

USER-FRIENDLY
LED DOWNLIGHT



TWO-PIECE DESIGN

User-friendly
As easy as replacing a bulb

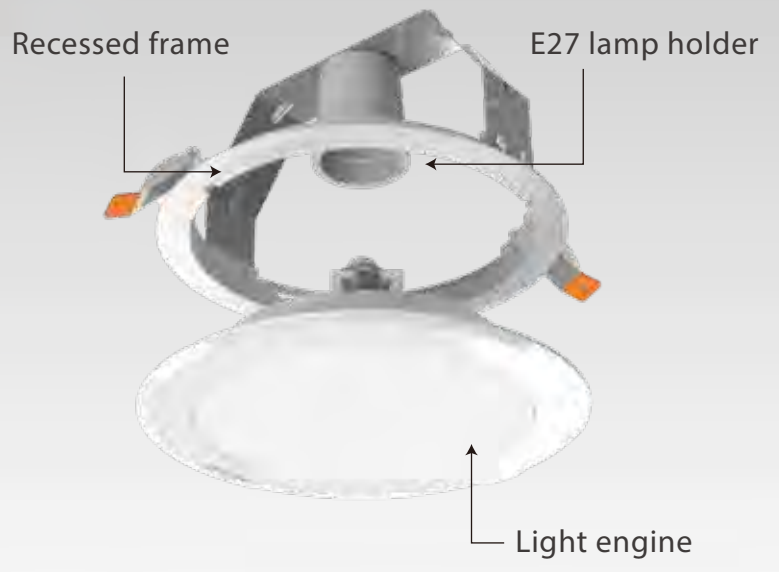
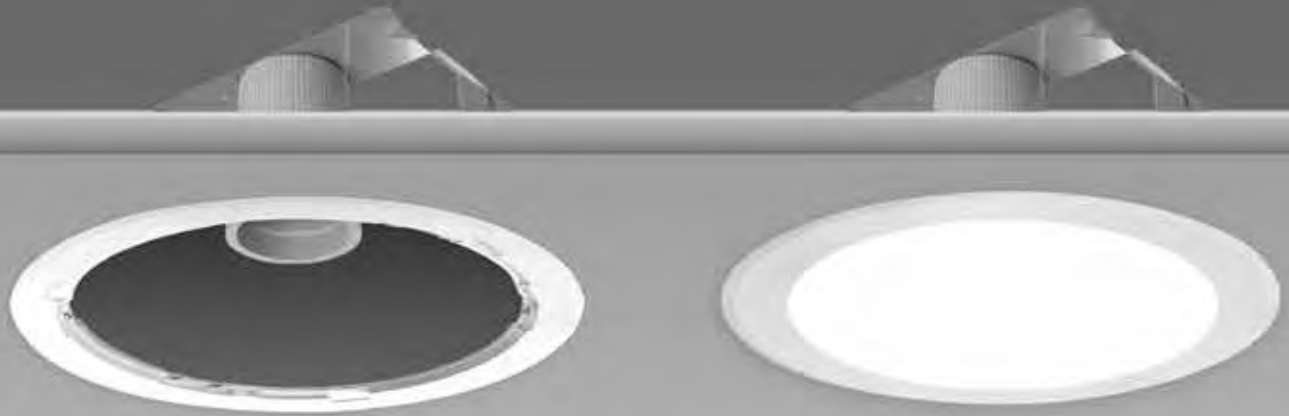

PRODUCT ADVANTAGES

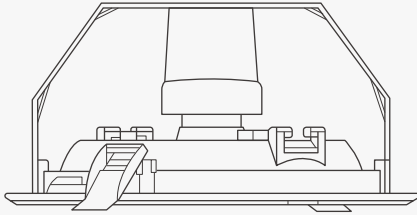

1. Replaceable Light Engine

As easy as replacing a bulb.

2. E27 holder

E27 holder frame that makes installation & replacement as easy as changing a bulb

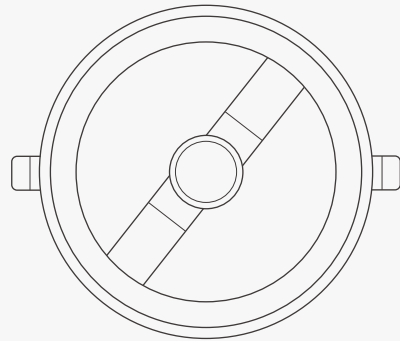

INSTALLATION GUIDE

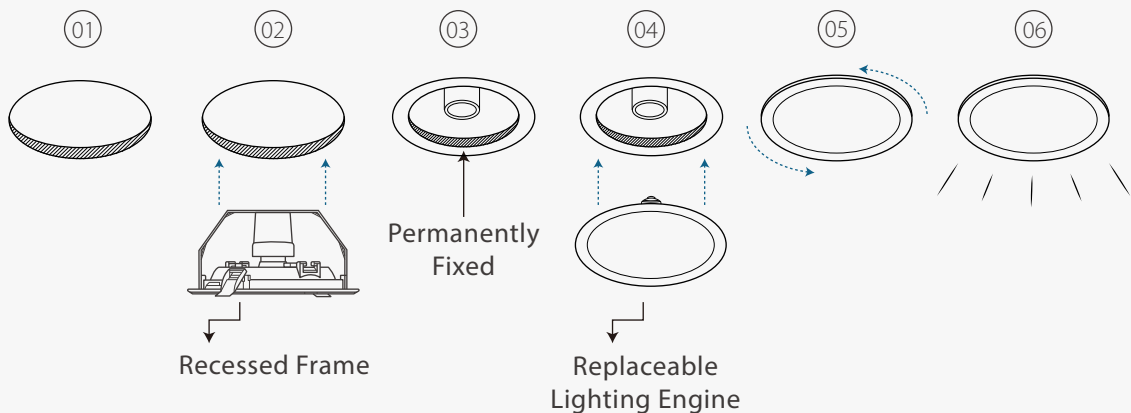

PRODUCT SPECIFICATIONS

AC Input: 100 ~ 240Vac

System Power: 15W ± 1W

Luminaire Efficacy Rating (LER): >85 lm/W

Luminous Flux: 1,230 lm

Color Temperature: 6500K (available for 3000K, 4000K)

Color Rendering Index (CRI): >80

Beam Angle: 120°

Operating Temperature: -20°C ~ +45°C

Storage Temperature: -20°C ~ +80°C

Lifetime (typical): 30,000 hours at ta 25°C

LED Lumen Maintenance: LM80

Electrical Safety: Class I

Compliant: IEC, CE

Weight: 600g

Luminaire Housing Material: Polycarbonate

Luminaire Color: White

IP Rating: IP20

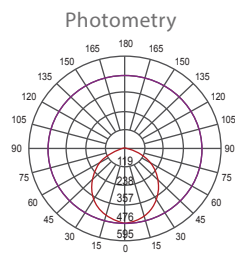

PRODUCT DIMENSIONS

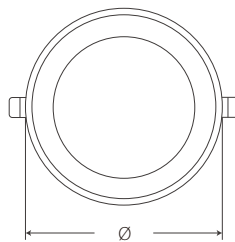
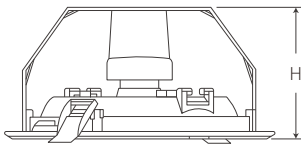

Detail	H	Ø
Size	87.0mm	171mm
Cut-Out	-	153mm



NexusLED®

Simple is Better

Designed and Manufactured By:

NexusLED Green Technology Sdn. Bhd. (893555-V)

No. 6, Jalan Sri Sulong Selatan, Taman Industri Sri Sulong, 83000 Batu Pahat, Johor, Malaysia. Tel: +607-4102 159 Fax:+607-4102 206

For inquiry please contact us at: info@nexusled.com

© 2022 NexusLED Green Technology Sdn. Bhd. All rights reserved. NexusLED does not give any representation or warranty as to the accuracy or completeness of the information included herein and shall not be liable for any action in reliance thereon. The information presented in this document is not intended as any commercial offer and does not form part of any quotation or contract, unless otherwise agreed by NexusLED. All trademarks are owned by NexusLED Green Technology Sdn. Bhd. or their respective owners.

Revision 182202



For More Information
Please Scan The QRCode
Or visit www.nexusled.com